



INSTALLATION GUIDE

SS087

RAID SIDE STEPS TO SUIT CHEVROLET SILVERADO



SS087/070922

- Ironman 4x4 SSR087 Side Steps to suit Chevrolet Silverado.
- It will take approximately 1.5 hours to install.
- Read instructions fully before commencing fitment. Check hardware kit contents against content list below. Do not use this product for any vehicle make or model, other than specified in these instructions.
- Do not remove labels from this Raid product. It is good practice to record the batch number on the customer's job card for future reference.

WARNING: This product has been tested for side air bag compatibility and therefore the mounting system **MUST NOT** be modified. The operations of the side air bags are not affected if installation is followed in accordance to these instructions.

IMPORTANT: Raid Accessory installations should only be done by a qualified person, and it is the responsibility of this person to ensure correct fitment.

Before Installation

IMPORTANT:

Raid Accessory installations should only be done by a qualified person, and it is the responsibility of this person to ensure correct fitment.

Read instructions fully before commencing fitment. Check hardware kit contents against content list below. Do not use this product for any vehicle make or model, other than specified in these instructions.

This product and or hardware must not be modified in anyway.

Do not remove labels from this Raid product. It is good practice to record the batch number on the customer's job card for future reference.

RAID ACCESSORY CARE INSTRUCTIONS:



To maintain finish of the product, wash regularly using a PH neutral Car wash, hose off and chamois dry. Do not use acidic or alkaline cleaners. Plastic components can be maintained with a silicon spray or similar (non-acidic or alkaline based)

The fitting instructions are correct at the time of publication date. Ironman 4x4 cannot be held responsible for any vehicle manufacturer changes. It is the installers responsibility to ensure correct fitment.

It is important to work safely and use appropriate safety equipment while working.



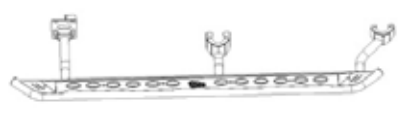
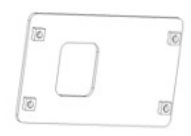

Side Step Parts List

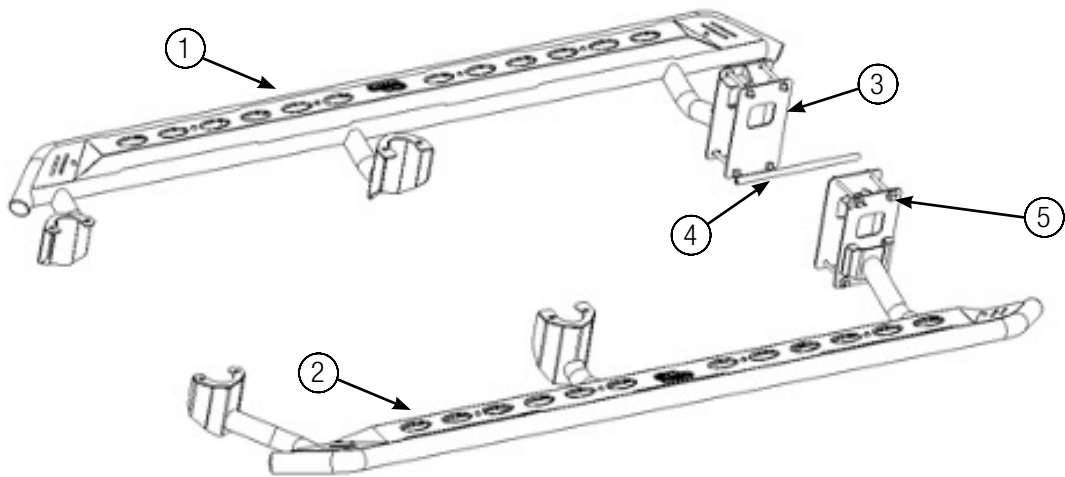
<p>1. Side Step LHS</p>  <p style="text-align: right;">QTY-1</p>	<p>2. Side Step RHS</p>  <p style="text-align: right;">QTY-1</p>	
<p>3. Inner Clamping Plate</p>  <p style="text-align: right;">QTY-2</p>	<p>4. Rubber insulation L=350mm</p>  <p style="text-align: right;">QTY-1</p>	<p>5. M10X1.5_120 hex bolt, flat washer, spring washer</p>  <p style="text-align: right;">QTY-8</p>

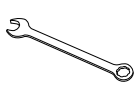
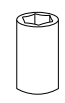
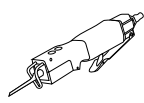
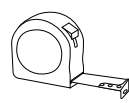
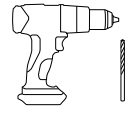

Tools Required

<p>Metric spanner set</p> 	<p>Metric socket set</p> 	<p>Air hacksaw</p> 	<p>Tape measure</p> 	<p>Drill and drill bits</p> 	<p>Screwdriver set</p> 
---	--	--	---	--	--

Bolt Tension Chart

Property Class	TORQUE ma	NOMINAL DIAMETER - COARSE THREAD			
		M6 x 1	M8 x 1.25	M10 x 1.25	M12 x 1.25
8.8	Nm	10.5	25	49	88
	ft/lb	7.7	18	36	64



1. Before installation, check the Raid sidesteps application is compatible with your vehicle.



2. If vehicle has factory fitted sidesteps remove now.

NOTE: it is advised that once factory side steps are removed, reinstall factory bolts to fill in the thread holes



3. Unwrap the hardware and sidesteps. It is good practice to lay out all hardware and cross reference against the parts list.



4. Start on the right-hand side of the vehicle. Locate the front and middle body bolts. Unbolt and keep bolts aside to re-install later.



5. Unbolt the factory 15mm nuts and retain to be reinstalled later.

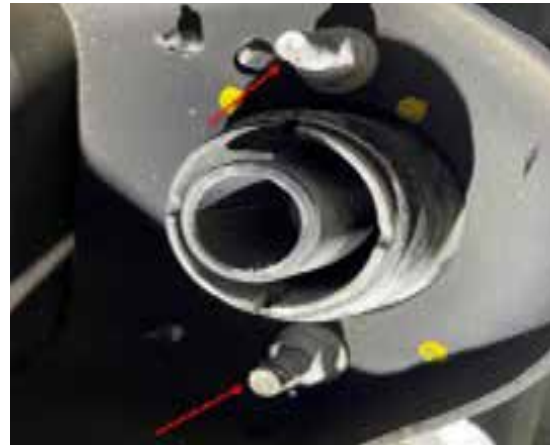

6. It is advised to use a jack or jack stands to support the steps.
With the help of another person, carefully lift the step into position, ensuring that the rear of the step is supported and align with the front and middle body bolts. Then attached the front and centre factory 15mm Nuts, leave loose and don't fully tighten at this stage.

7. Now move to the rear, feed the rear chassis mount plate up along the inside of the chassis rail.



8. **NOTE:** it is advised to place rubber insulator on the right-hand upper fuel lines.



9. Fit all 4x M10 bolts and washers.



10. Once steps are aligned and square tighten to torque specs on page 2.



11. Repeat steps 4-12 on the left side of vehicle.



Once the Raid Side Steps are Installed

Ensure all bolts are tensioned correctly, it is good practice to do a vehicle pre trip check before heading away or every 10k kms. Visually inspect bull bar and hardware, retention bull bar hardware or when needed.

Stand back and admire your work.

